

DC High-efficiency Backward Curved Centrifugal Fan

Erp2015
EXCEEDS THE NORM

Motorized Backward Curved Impeller



Φ 175

Rotor Material: Carbon steel
Impeller Material: Plastic
Ingress Protection: IP42
Insulation Class: F
Bearing Type: Maintenance free ball bearing

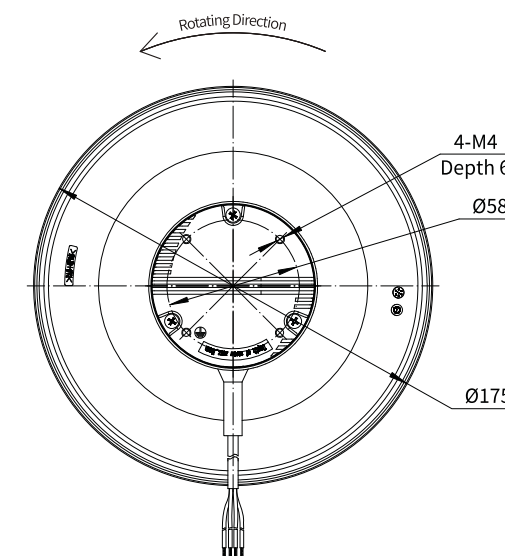
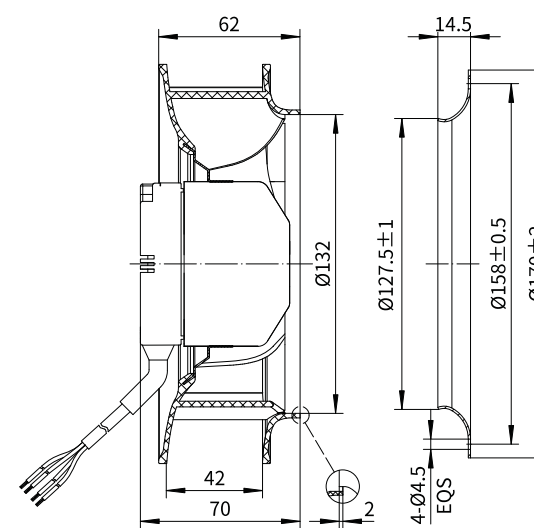

Performance Curves

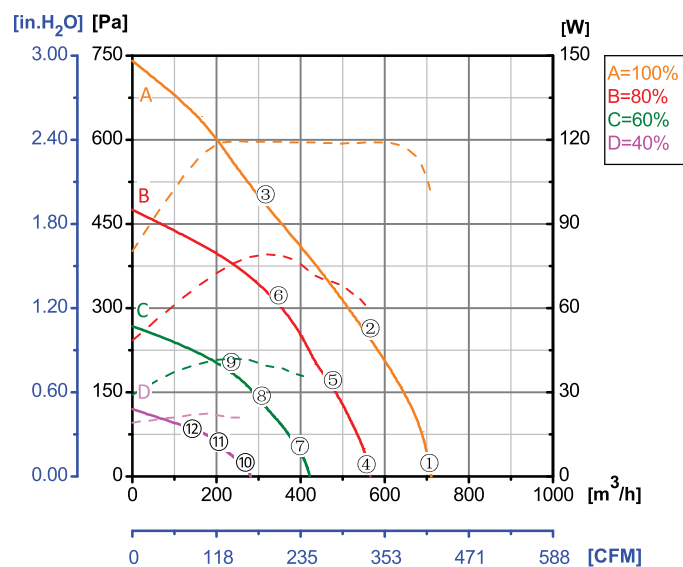

Test Point	Speed	Input Power
	rpm	W
1	3040	78
2	2974	78
3	2814	77
4	2433	42
5	2435	45
6	2438	53
7	1821	21
8	1830	22
9	1824	24
10	1222	9
11	1232	10
12	1228	11

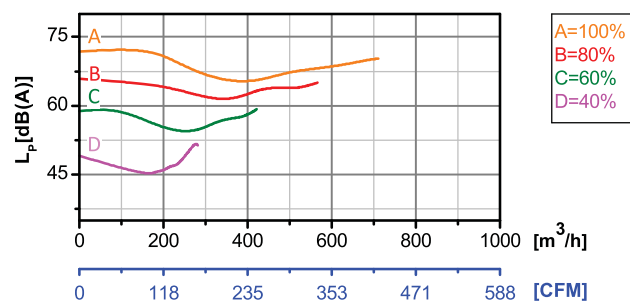

Erp2015 Data:
Efficiency η_{statA} =40.6%
Efficiency grade N_{actual} =49, N_{target} =40
Test report No. : L-20210302-004-087

Model No.	Voltage	Frequency	Speed	Input Power	Current	Working Temp.	APProvals
	VAC	Hz	RPM	W	A	Min/Max (°C)	
DC72-B175-D10	310	/	4500	110	0.36	-20/+60	CCC,CE

High-efficiency B/C Centrifugal